

## DOCUMENT NUMBER AND REVISION

QA-160308-01 / Rev. 0.1

## DOCUMENT TITLE

## SPECIFICATION OF NEP0550

ITEM	TOUCH SCREEN MONITOR
MODEL	NEP0550
NEXIO PRODUCT NO.	NEP0550-PLAX070B1S2-TMAG-V2
CUSTOMER PRODUCT NO.	-
CUSTOMER	-
DATE	2016. 03. 08

APPROVED BY CLIENT

APPROVED BY NEXIO	
PROPOSER	KIM S. S .
REVIEWER	
APPROVER	KIM L. H.

**Nexio Co., Ltd.**

5F, Seong-Woong B/D, 898-3 Jakjun-dong,

Gyeyang-gu, Incheon, Korea

Tel : +82 32 556 9545 ~ 7

Fax : +82 32 556 9544

## CONTENTS

1. DOCUMENT REVISION HISTORY .....	3P
2. MONITOR SPECIFICATIONS .....	4P
3. TOUCH SPECIFICATIONS .....	4P
4. MECHANICAL SPECIFICATIONS.....	5P
5. SUPPORTING FORMAT.....	5P
6. CONENCTOR INTERFACE .....	6P
7. ENVIRONMENT CONDITIONS .....	6P
8. ELECTRICAL SPECIFICATIONS .....	6P
9. STANDARD .....	6P
10. DRAWING SPECIFICATIONS .....	7P
11. LABEL INFORMATIONS .....	8P
12. PACKING SPECIFICATIONS .....	9P

**1. DOCUMENT REVISION HISTORY**

Date	Rev. No	Page	Description
2016.03.08	0.1		Specification of NEP0550 model was issued first.

## 2. MONITOR SPECIFICATIONS

ITEMS		SPECIFICATION
Panel	Screen Diagonal	54.64 inch
	Active Display Area	1209.6 x 680.4mm
	Display Type	Landscape and Portrait Enabled
	Max. Resolution	1,920 x 1,080
	Color Depth	10Bits , 1.06 B Colors
	Pixel Pitch	0.630 x 0.630mm
	Surface Luminance, White	700 cd/m <sup>2</sup> (Typ.)
	Contrast Ratio	1300 (Typ.)
	Response Time (G to G)	8ms (Typ.)
	Viewing Angle	178°(H), 178° (V) Typ.
	Lamp Life Time	60,000Hrs (Typ)
Input Video Signal		15Pin D-SUB Female Connector 29 Pin DVI-D Connector 19 Pin HDMI Connector
Audio	Input	Ø3.5 Phone Jack x 1 for PC
	Output	Ø3.5 Phone Jack x 1 for Headphone
Control / OSD		SOURCE, MENU, LEFT, RIGHT, DOWN, UP, POWER, LED
Plug & Play		VESA DDC2B
Power Management		VESA DPMS

## 3. TOUCH SPECIFICATIONS

ITEMS	SPECIFICATION
Touch Type	PCAP (Projected Capacitive)
Touch Input Method	Finger, Pen(Capacitive)
Number of Touch Point	10 Points Multi-Touch
Available Object size	Ø9mm(Finger), Ø3mm(Pen)
Response Time	5~15ms
Thickness	5.39mm(Glass : 5mm, Sensor : 0.39mm)
Transmittance	83%(Min.)
Surface Hardness	5H
Position Accuracy	Within 1.0mm
Interface	USB 2.0 FS, HID Compliant Plug & Play
Supported OS	Windows 7/8, Linux, Android, Mac(Driver software)

#### 4. MECHANICAL SPECIFICATIONS

ITEMS	SPECIFICATION
Outline Dimension (HxVxD)	1260.1±1.2mm x 738.7±0.8mm x 89.7±0.3mm
Weight(Net/ Gross)	TBD
Standard Accessory	HDMI Cable, USB Cable, Power Cord
VESA Mount Size	400 x 400 (mm) , M6

#### 5. SUPPORTING FORMAT

VGA (Analog RGB & DVII)

ITEM	STD	Resolution	Pixel Frequency (MHz)	Vertical Frequency (Hz)	Horizontal Frequency (KHz)	Sync. Polarity (H/V)	Remark
1	VESA	640*350	31.500	85.080	37.861		
2		640*400	25.175	59.940	31.469		
3	VESA	640*400	31.500	85.080	37.861		
4		640*480	25.175	59.940	31.469		VGA
5	VESA	640*480	25.200	60.000	31.500		VGA
6	VESA	640*480	31.500	72.809	37.861		VGA
7	VESA	640*480	31.500	75.000	37.500		VGA
8	VESA	640*480	36.000	85.008	43.269		VGA
9	IBM	720*400	28.322	70.087	31.469		
10	VESA	720*400	35.500	85.039	37.927		
11	VESA	800*600	36.000	56.250	35.156		SVGA
12	VESA	800*600	40.000	60.317	37.879		SVGA
13	VESA	800*600	50.000	72.188	48.077		SVGA
14	VESA	800*600	49.500	75.000	46.875		SVGA
15	VESA	800*600	56.250	85.061	53.674		SVGA
16	VESA	1024*768	65.000	60.000	48.363		XGA
17	VESA	1024*768	75.000	70.069	56.476		XGA
18	VESA	1024*768	78.750	75.029	60.023		XGA
19	VESA	1024*768	94.500	84.997	68.677		XGA
20		1152*864	94.500	70.012	63.851		
21	VESA	1152*864	108.000	75.000	67.500		
22		1280*720	74.501	59.856	44.772		WXGA
23		1280*768	79.499	59.870	47.776		WXGA
24	VESA	1280*960	108.000	60.000	60.000		WXGA
25	VESA	1280*960	148.500	85.002	85.938		WXGA
26		1360*768	72.000	59.960	47.368		WXGA
27		1360*768	109.001	74.892	60.288		WXGA
28	VESA	1280*1024	108.000	60.020	63.981		SXGA
29	VESA	1280*1024	135.000	75.025	79.976		
30	VESA	1280*1024	157.500	85.024	91.146		
31		1680*1050	146.250	59.954	65.290		WSXGA+
32	VESA	1600*1200	162.000	60.000	75.000		UXGA
33		1920*1080	138.500	59.934	66.587		
34		1920*1080	148.500	60.000	67.500		1080P
35		1920*1080	148.352	59.940	67.433		1080P
36		1920*1200	154.125	59.999	74.099		WUXGA

## 6. CONNECTOR INTERFACE

ITEMS	DESCRIPTION	
<b>HDMI</b>	HDMI	
<b>DVI-D</b>	Digital Input	
<b>D-SUB 15P</b>	RGB	
<b>PC Audio Input</b>	HDMI Jack, 3.5 $\phi$ Stereo Phone Jack	
<b>Headphone Output</b>	3.5 $\phi$ Stereo Phone Jack	
<b>USB (Touch Interface)</b>	Connector	USB Type 'B' Female
	Power	USB Powered
	Protocol	Human Interface Device(HID)
	Operation	Plug & Play
	Speed	USB 2.0 Full Speed

※Notice 1 : Do not set battery mode or power save mode in computer power option.

※Notice 2 : The standard of USB communication length is 5M(refer to usb.com)

When you use USB extension Cable, data loss and degradation might be able to be occurred.

In order to minimize data loss and degradation according to USB extension Cable using,

We highly recommend Repeater using to provide external power supply.

## 7. ENVIRONMENTAL CONDITIONS

ITEMS	SEPECIFICATION
<b>Operating Temperature</b>	0 ~ 50 °C
<b>Operating Humidity</b>	10 ~ 90% (Non Condensing)
<b>Storage Temperature</b>	-20 ~ 60 °C
<b>Storage Humidity</b>	10 ~ 90% RH(Non Condensing)

## 8. ELECTRICAL SPECIFICATIONS

ITEMS	SEPECIFICATION
<b>Power Supply</b>	AC 100V~240V (50/60Hz)
<b>Power Consumption</b>	315 Watt (Max.)
<b>ESD</b>	TBD

## 9. STANDARD

ITEMS	SPECIFICATION
<b>RoHS</b>	Compliant with restriction of hazardous substances directive 2002/95/EC and additional RoHS 2.0 requirements
<b>ESD handling</b>	TBD
<b>REACH standard</b>	TBD





11. LABEL INFORMATIONS

Product Ordering Information에 따라 변경 부여한다.

CUSTOMER		MODEL	NEP
DESCRIPTION	NEPXXXX-XXXX -XXXX-XXXX-XX	Q'TY	
		1EA	
S/N	※ Serial No.는 생산에서 자체 부여한다.		

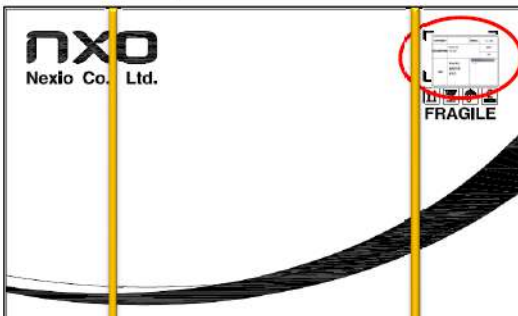



좌측 그림과 같이 지정된 위치에 Carton Label을 2곳에 붙인다



12. PACKING SPECIFICATIONS

①

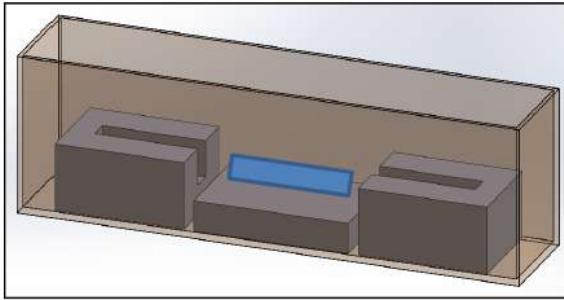

1. BOTTOM BOX에 ACCESSORY CABLE 과 CORNER FOAM 2EA , MID PAD를 넣는다.

②

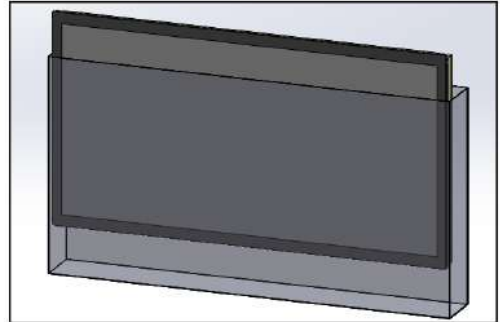

2. PE BAG에 NEP SET를 넣는다.

③

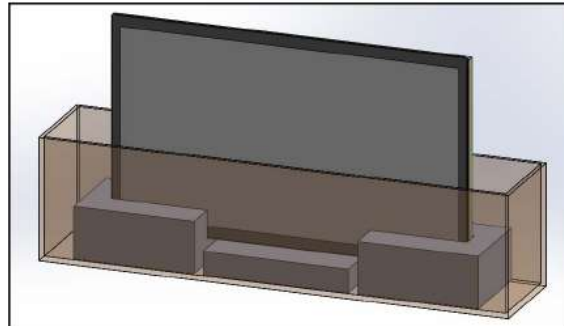

3. BOTTOM BOX에 NEP SET를 넣는다.

④

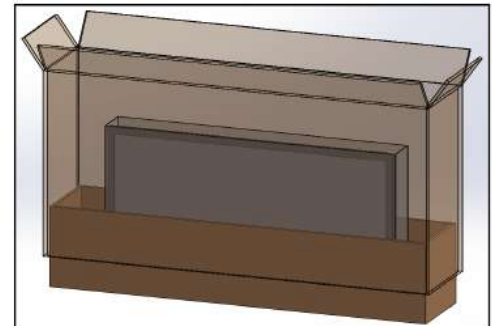

4. TOP BOX를 씌운다.

⑤

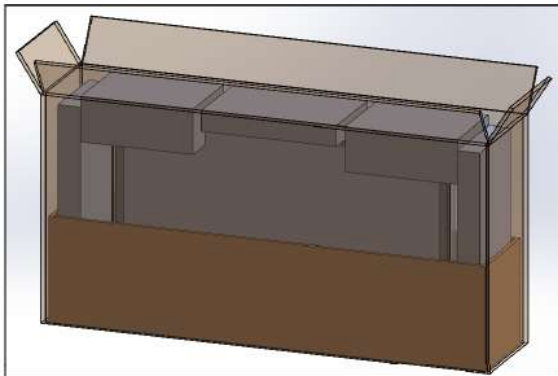

5. BOX 안에 CORNER FOAM 2EA와 SIDE PAD 2EA, MID PAD 1EA 를 넣는다.

⑥

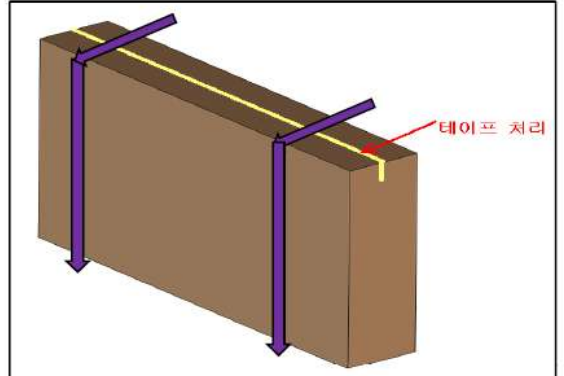

6. 그림과 같이 BOX를 닫고 OPP Tape를 바른 후 보라색 화살표와 같이 밴딩을 2곳 처리 한다. (밴딩 거리는 좌,우 측면에서 190mm정도)

**Note:** This information is subject to change without prior notice.